

**Nanodyne Replacement Illuminator for Leica Microstar IV Microscope Installation Instructions: Included Items**

**Additional Items Included But Not Shown:**

- PN 10703 Hex Key 0.05 inch - for knob
- PN 10490 Hex Key 5/64 inch - for set screw
- PN 10709 Hex Key 3/32 inch - for 4-40 screws
- PN 10610 cable ties (4pcs) - to secure pot cable

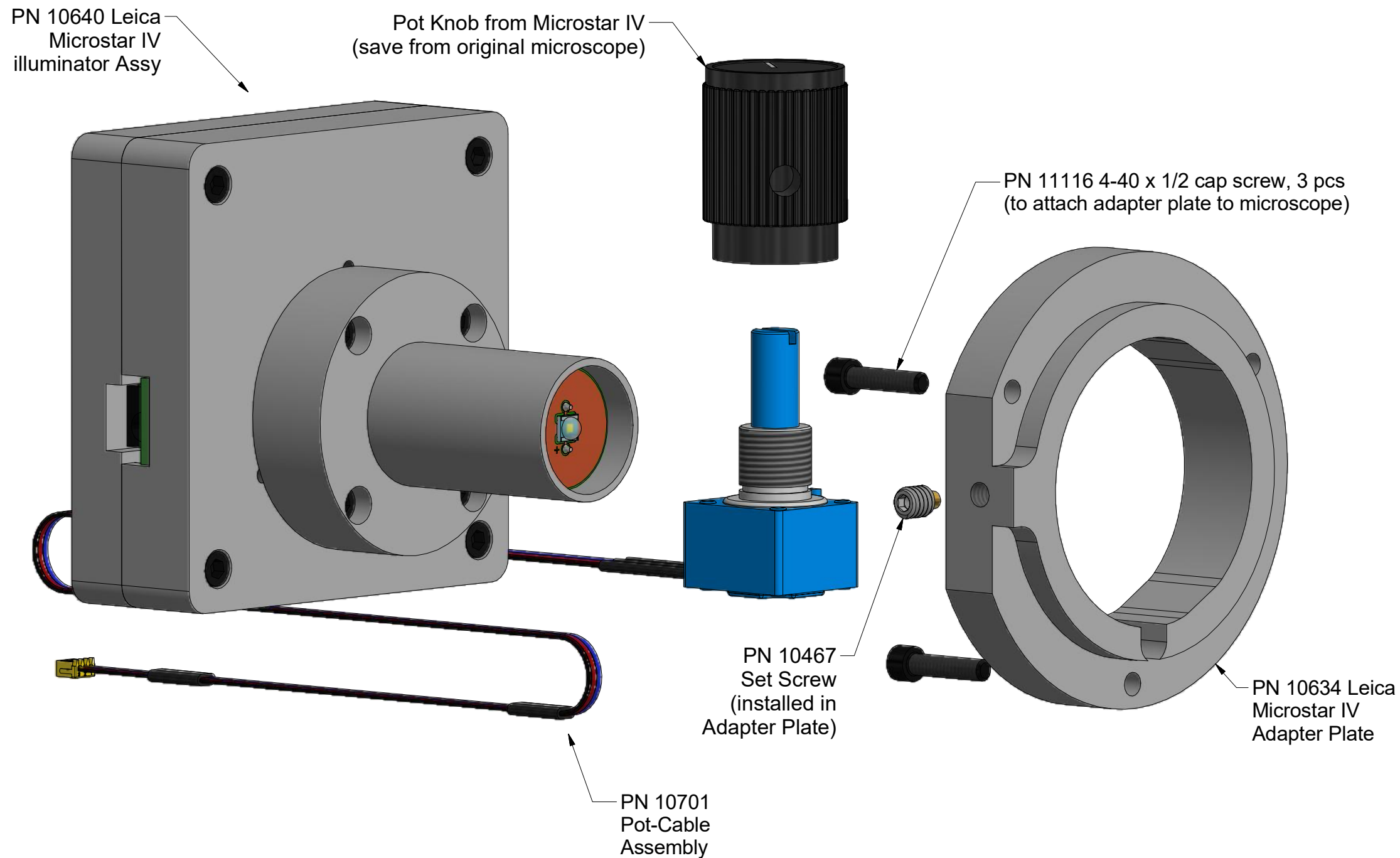

PN 10733 Power Supply - XP Power 5V 1A and PN 10734 Cable 6 foot USB A to 1.35mm ID/3.5mm OD RA Barrel Plug.

The illuminator may be powered by plugging the cable into the power supply provided, or into a suitable USB port on a computer or other device.



PN 10736 Rubber plug to block unused AC power recepticle.

Power supplies are subject to substitution without notice due to availability issues and changes in regulations.

Wayne Bonin	3/10/2019
PN 10698 Leica Microstar IV Installation Instructions	REV 6
SHEET 1 OF 7	



Nanodyne Replacement Illuminator for Leica Microstar IV Microscope Installation Instructions: Step 1. Remove Bottom Cover, Old lamp, and Old Pot

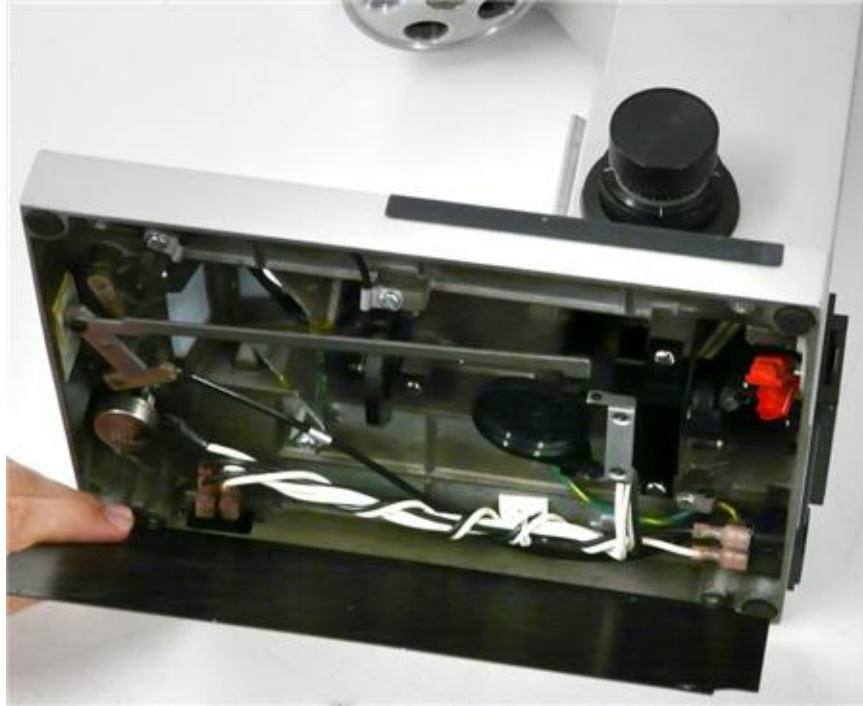

(1) Remove the bottom cover of the microscope.

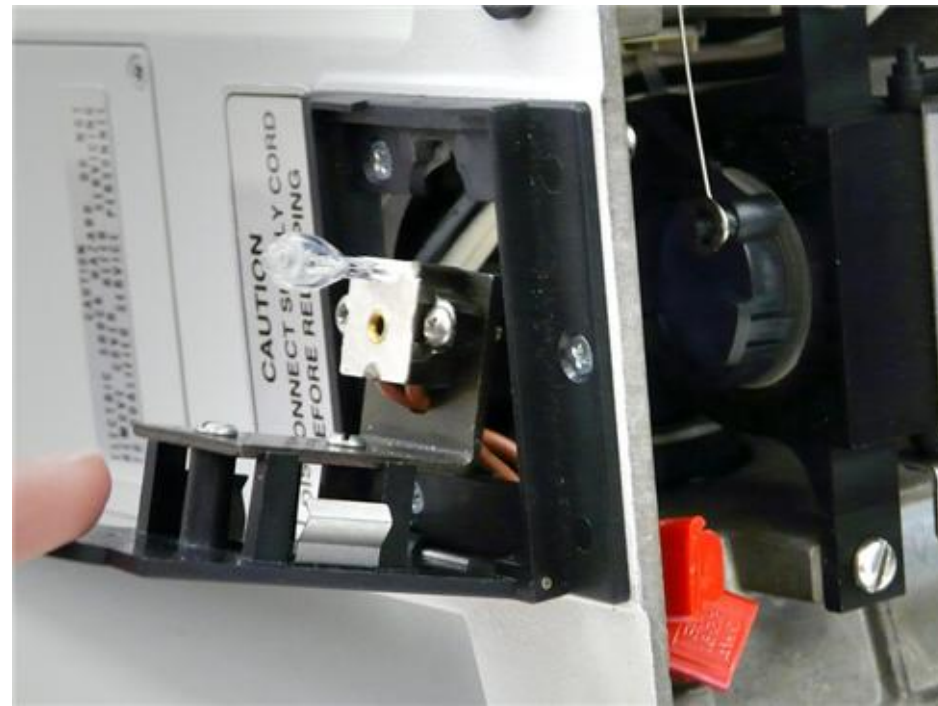

(2) Old lamp housing to be removed.

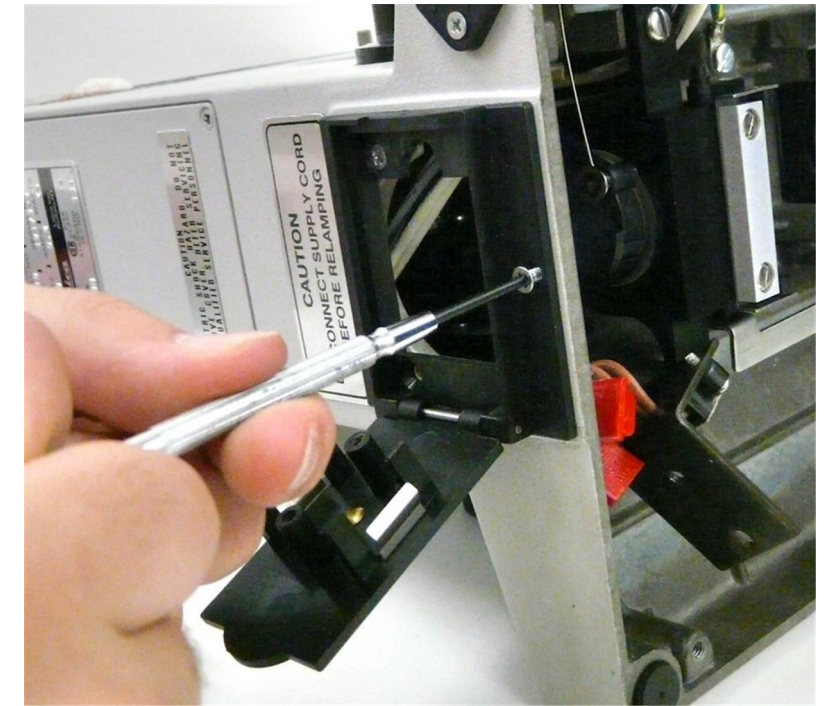

(3) Remove the old lamp housing. The photo shows the bulb socket disconnected from the housing but that is unnecessary. You can just cut the wires to the bulb, and insulate the cut ends.



(4) Using the hex key provided, loosen the set screw holding the brightness knob on the old pot.

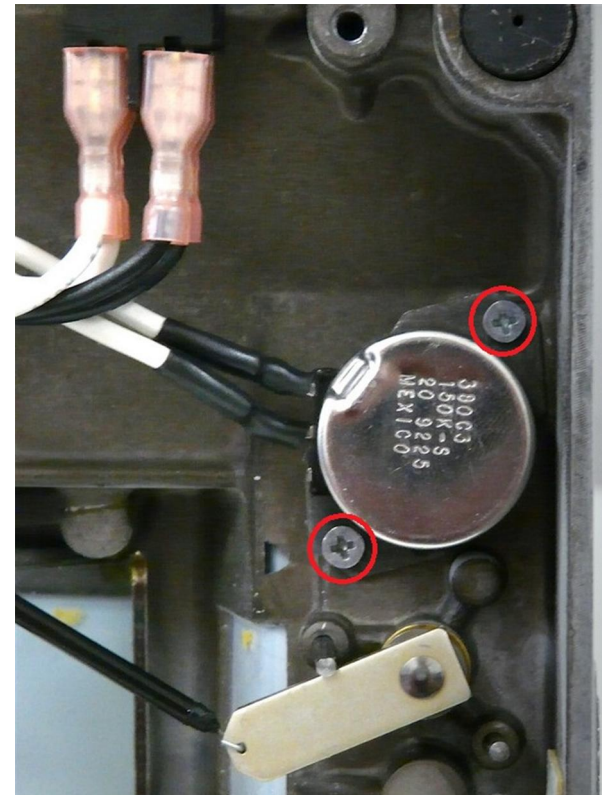

(5) From inside the microscope, use a phillips screw driver to remove the plate holding the pot.

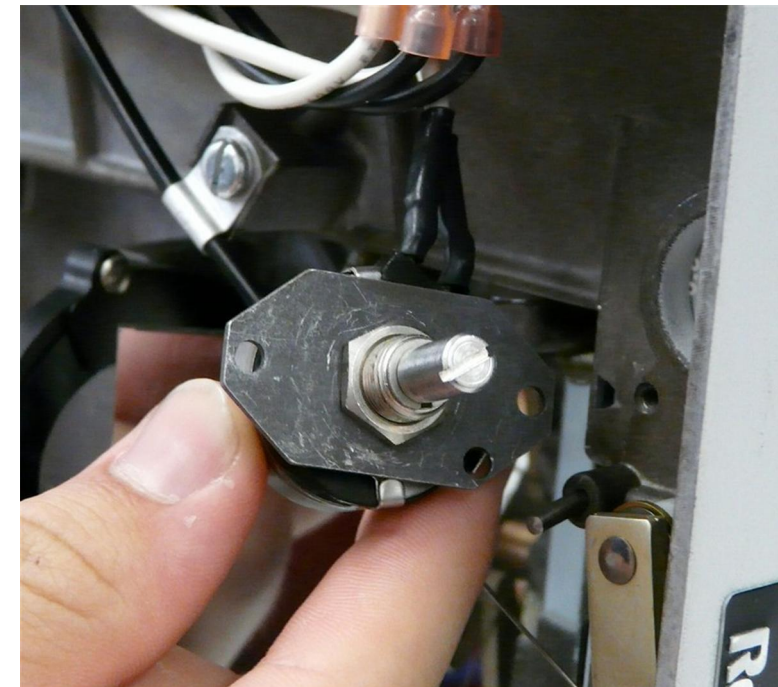

(6) Use a wrench to remove the nut holding the old pot to the plate holding the pot. Keep the plate to install the new pot.

Wayne Bonin	3/10/2019
PN 10698 Leica Microstar IV Installation Instructions	REV 6
SHEET 2 OF 7	



Nanodyne Replacement Illuminator for Leica Microstar IV Microscope Installation Instructions: Step 2. Install new potentiometer and Mounting Adapter

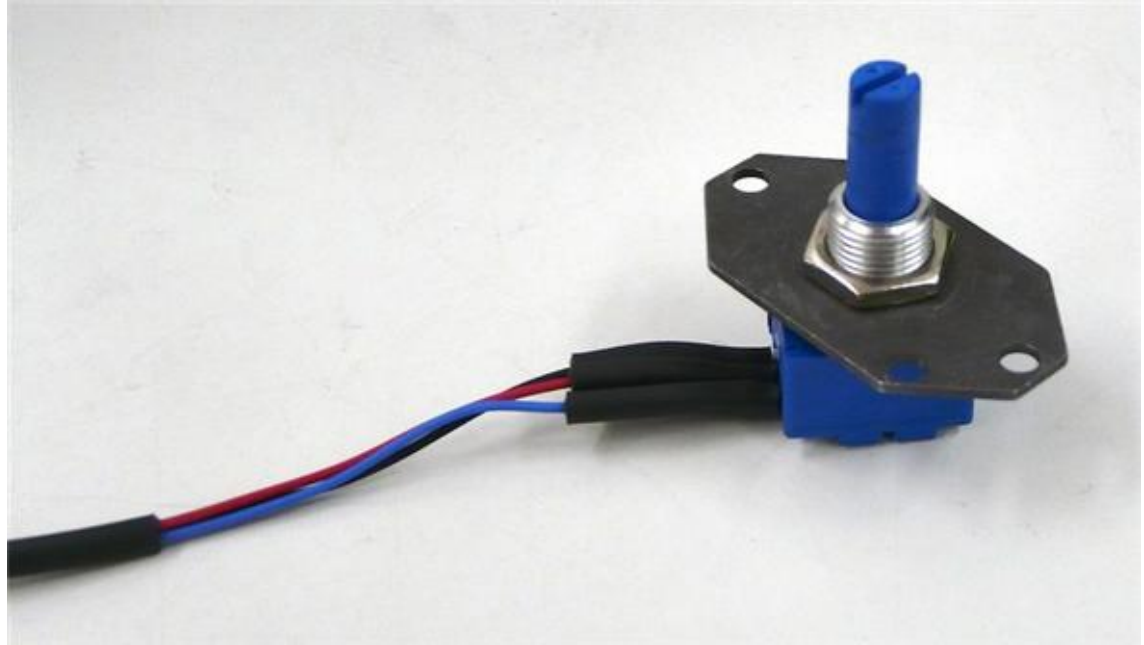

**(1)** Mount the new pot on the old plate as shown. Use the new nut and washer supplied with the pot. The washer goes under the plate against the pot.

**(3)** Replace the adjustment knob, reversing the removal procedure.

**(4)** Nanodyne mounting adapter with screws. This side goes against the microscope.

**(2)** (Not shown) Install the pot plate back in the microscope as it was, using the original screws.



**(5)** Install the adapter as shown. Use the 3/32 hex key to tighten the 4-40 screws.

**(6)** (Not shown) Route the pot cable so out the back of the microscope, with it resting in the groove in the bottom of the adapter.

Wayne Bonin	3/10/2019
PN 10698 Leica Microstar IV Installation Instructions	REV 6
SHEET 3 OF 7	



Nanodyne Replacement Illuminator for Leica Microstar IV Microscope Installation Instructions: Step 3. Install Nanodyne Illuminator

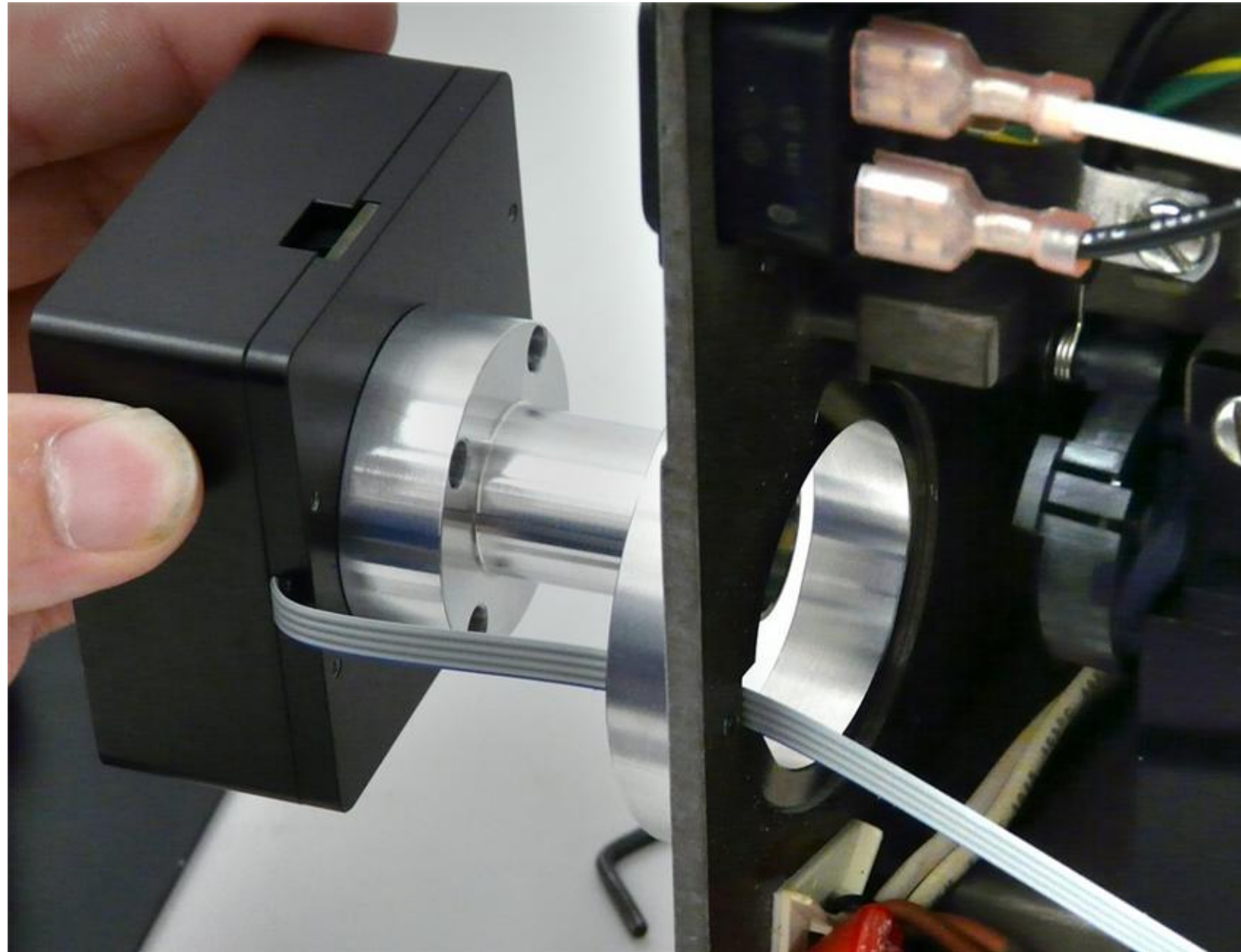

(1) Route the pot cable as shown (note yours will have 3 colored wires rather than 4 gray wires as shown). Connect the pot cable to the illuminator. See detailed instructions on sheet 5.

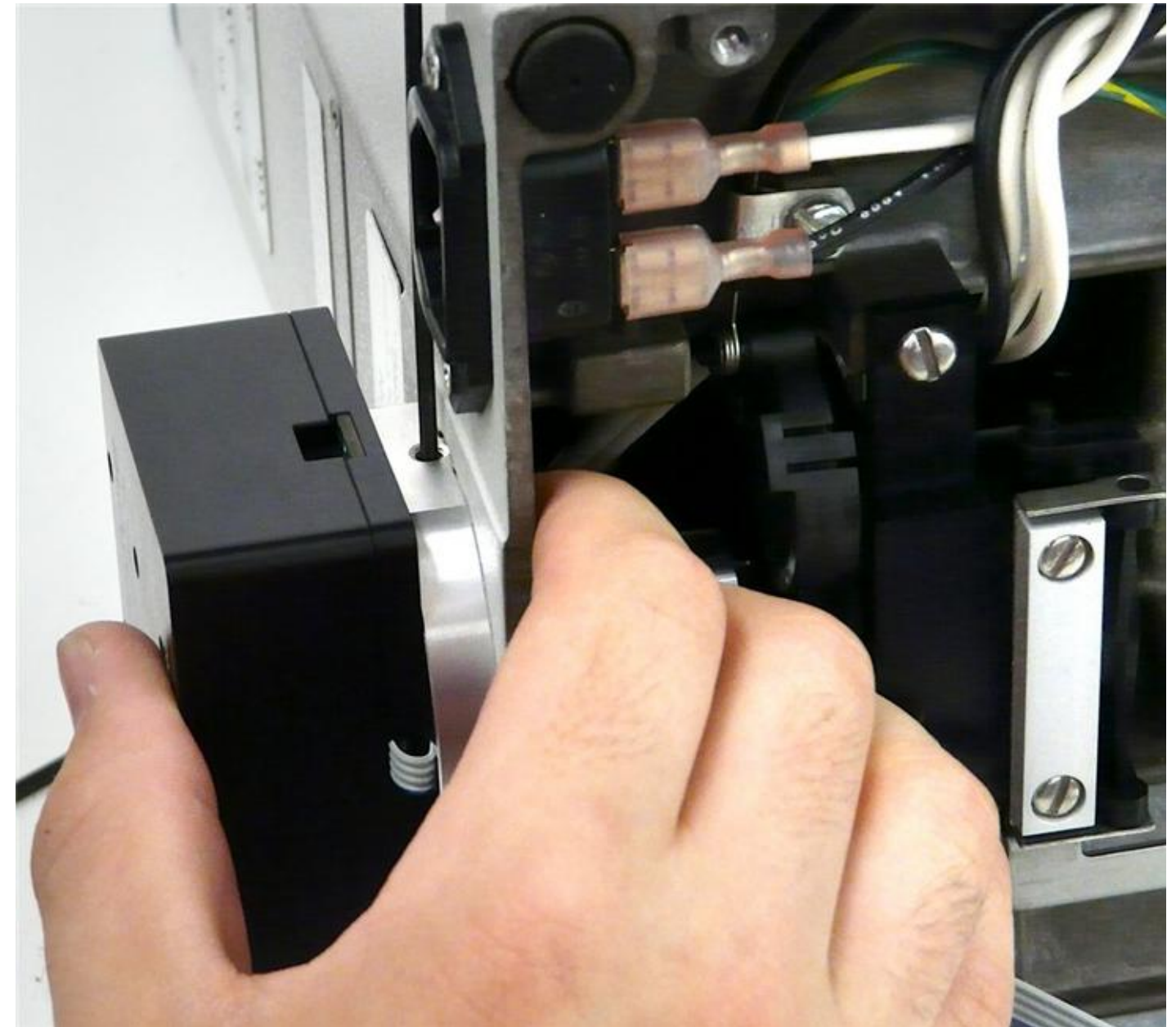

(2) Secure the illuminator as shown, locking it in place by tightening the set screw with the 5/64 hex key.

Note that the photos show an older version of the illuminator and an obsolete version of the pot cable. Your pot cable has three separate wires. Red, blue and black, as shown on sheet 1.

Wayne Bonin	3/10/2019
PN 10698 Leica Microstar IV Installation Instructions	REV 6
SHEET 4 OF 7	



## Nanodyne Replacement Illuminator for Leica Microstar IV Microscope Installation Instructions: Pot Cable Connection Details

Connect the plug at the end of the Pot Cable Assembly to the mating socket of the illuminator, as shown in the pictures on this page. NOTE THAT THE PLUG IS KEYED TO ONLY GO INTO THE SOCKET ONE WAY, AS SHOWN.

Partially insert the plug into the mating socket of the illuminator by holding the wire next to the plug with your finger (photo 2).

Use your fingernails, if you have them, or tools like a tiny screwdriver or tweezers pushing on the side of the plug to fully insert it (photo 3).

The socket cannot be fully engaged by pushing on the wires, as the wires would just collapse.

To disconnect it if needed, pull the wire straight out by firmly gripping the black heat shrink tubing.

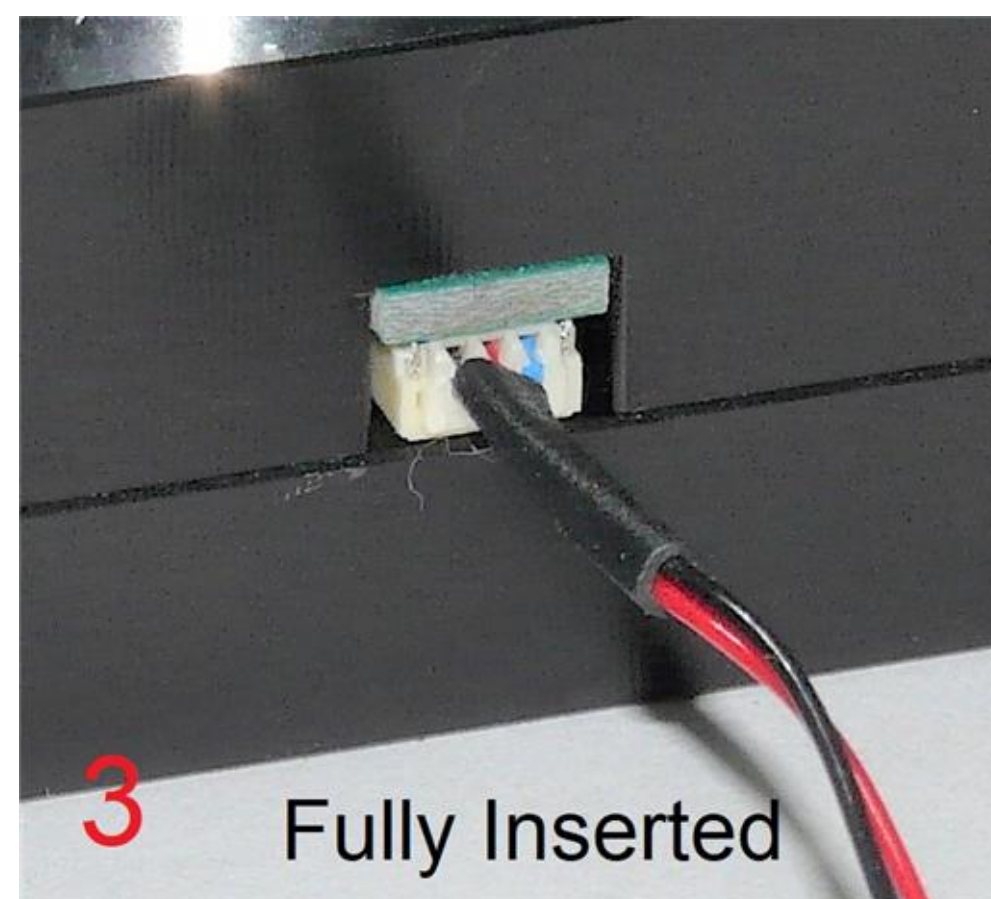
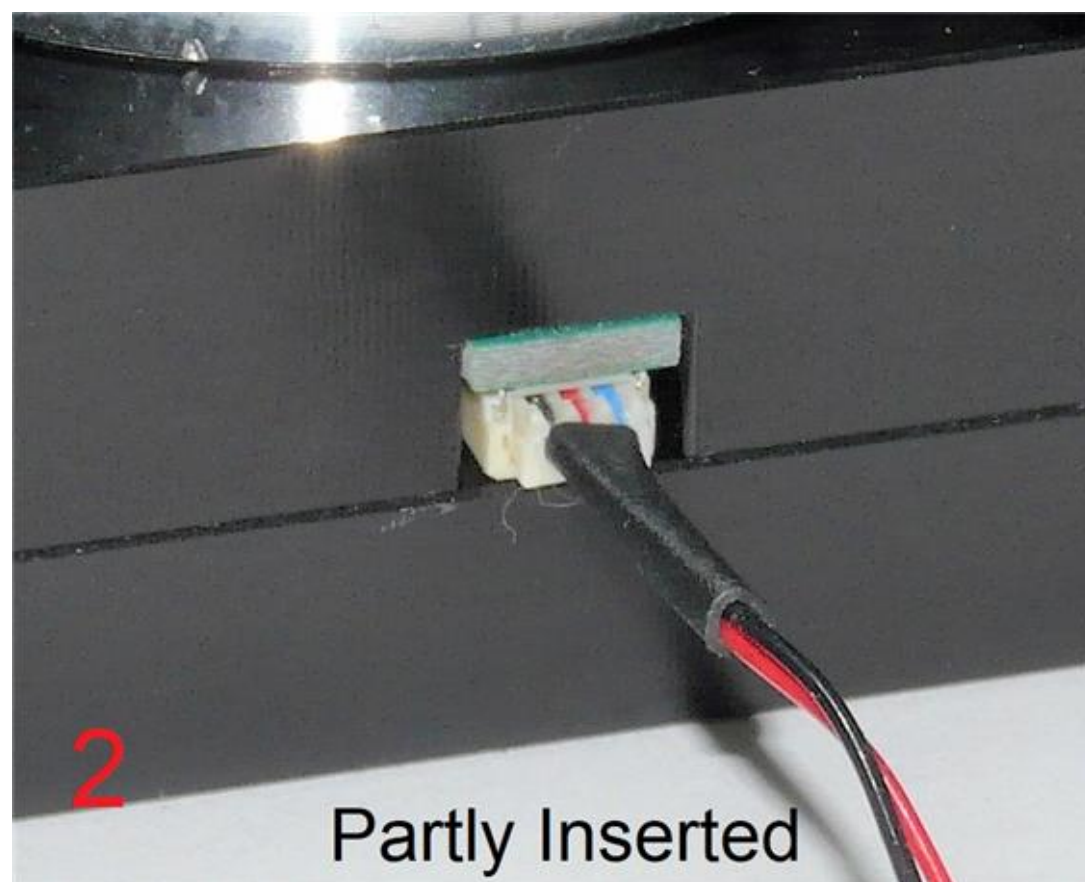
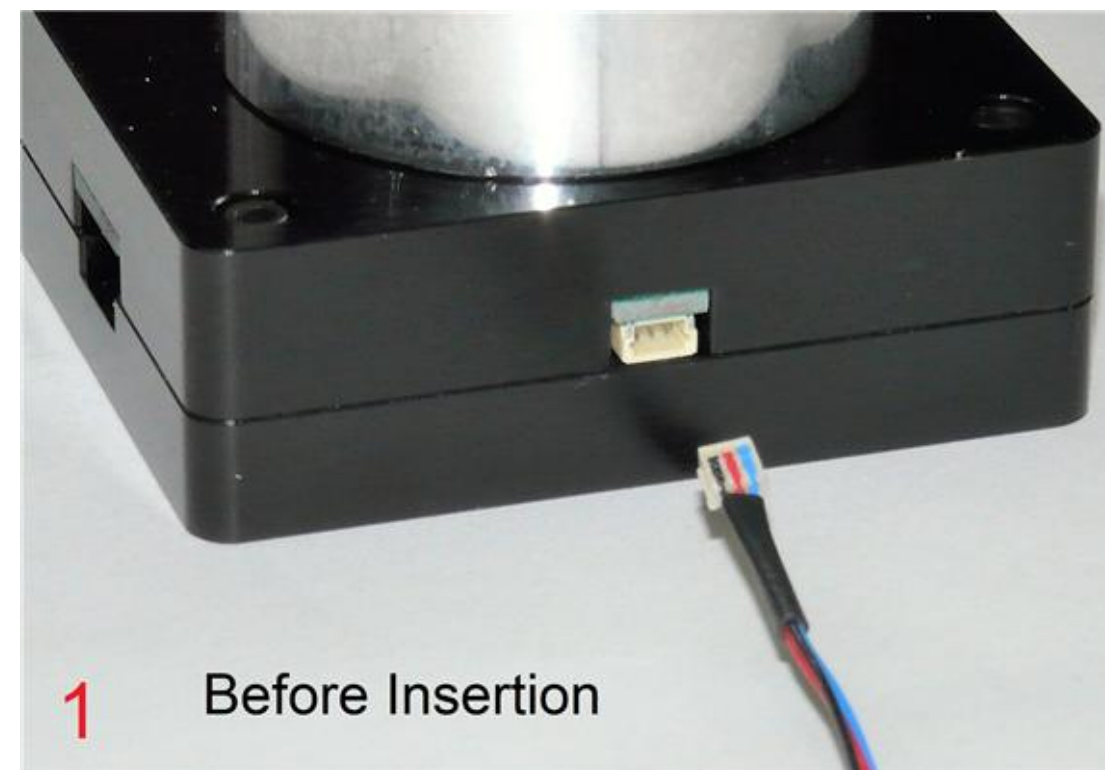



Nanodyne Replacement Illuminator for Leica Microstar IV Microscope Installation Instructions: Step 4. Remove AC Power Connections, Remove Unneeded Parts

**DO NOT** leave the internal AC power wires connected to the receptacle. This would create a hazard if AC power were connected to the unit after the new installation.

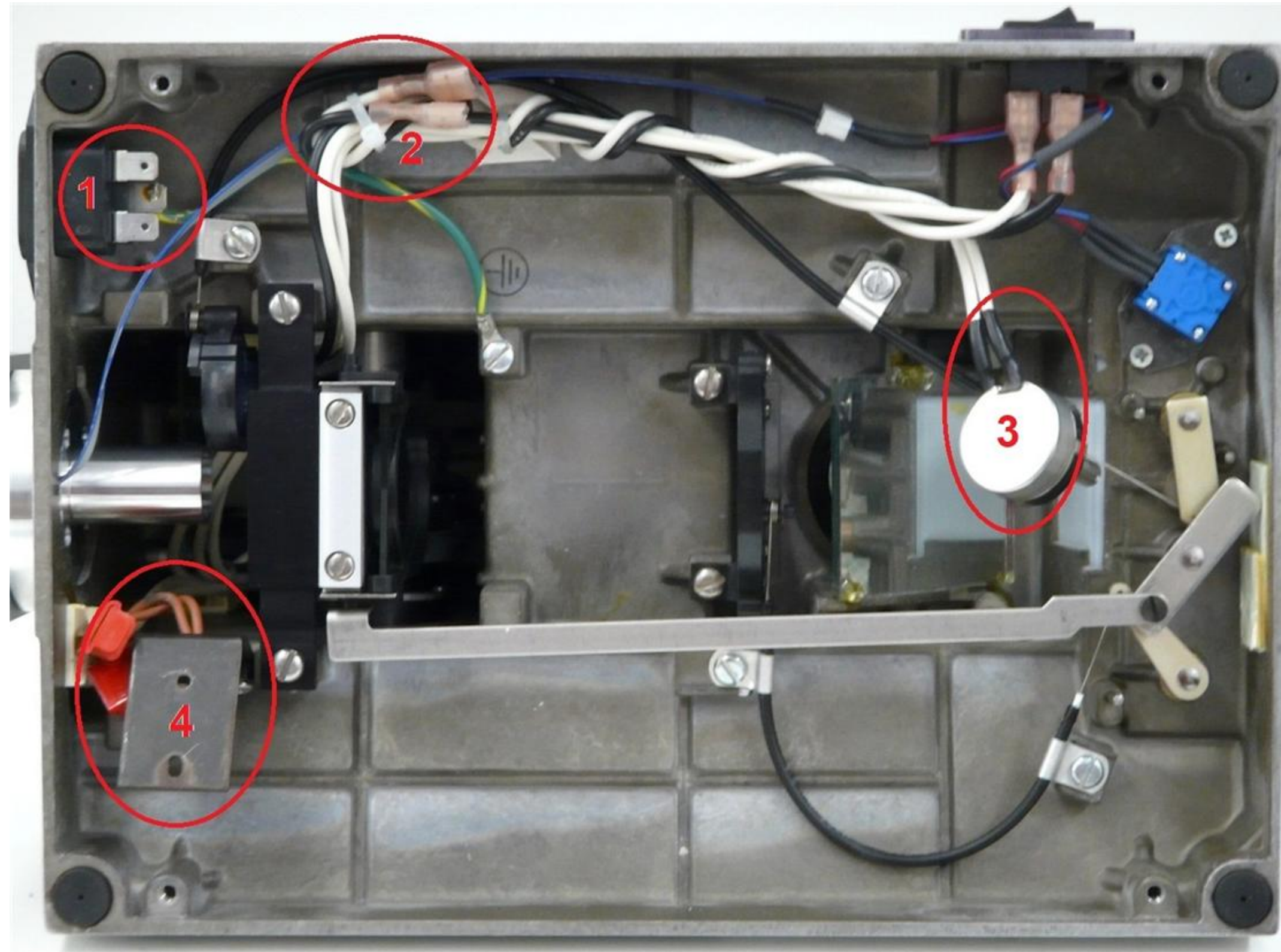

1. Disconnect the white and black wires from the AC receptacle.
  2. Secure the wires with a tie wrap so they cannot contact the terminals on the AC receptacle.
  3. Cut the white wires and discard the old pot.
  4. Cut the brown wires and discard the old lamp socket and bracket.
- When done with the above, replace the bottom cover.

(1) (Almost) completed unit ready to replace bottom cover. Note that this unit was borrowed so we could take the pictures. We could not cut wires which you will do for your install. See details at right of photo.

Wayne Bonin	3/10/2019
PN 10698 Leica Microstar IV Installation Instructions	REV 6
SHEET 6 OF 7	



Nanodyne Replacement Illuminator for Leica Microstar IV Microscope Installation Instructions: Step 5. Install AC Blocking Plug and Connect Power Supply



(1) Rubber AC blocking plug Ready to install.



(2) Rubber AC blocking plug installed in obsolete AC receptacle.

(3) (Not shown) Connect the USB end of the power supply cable to the power supply. Connect the other end to the illuminator in the receptacle circled in red. Plug the power supply into an AC outlet and the system is ready to use.

Wayne Bonin	3/10/2019
PN 10698 Leica Microstar IV Installation Instructions	REV 6
SHEET 7 OF 7	